

251TX.3L

Designed for linen replacement suitable for all hospital departments.

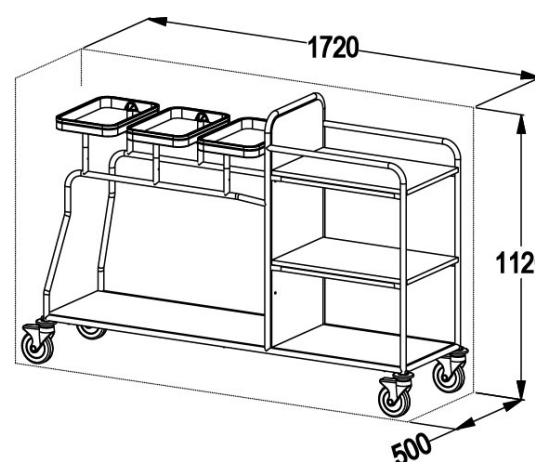

Multipurpose trolley divided into two parts, one for clean laundry and one for dirty laundry, separated by a vertical wall.

Its rugged frame is made of AISI 304 stainless steel (1.4301) completely TIG welded at all joints to avoid water infiltration and dirt buildup, ensuring perfect hygiene. Bottom, shelves and dividing wall are made of 18 mm thick wood panels, covered with melamine sheet and with ABS profiles along the edge.

The two tubes running above the shelves build a comfortable push handle.

Open trolley with 3 shelves for transport of clean linen and 3 bag holders for soiled collection.

Internal Height	Internal Width	Internal Depth	External Height	External Width	External Depth	Position	Ring Size	Diameter Wheels
0	0	0	1120	1720	500	D	350x255	125