

AXLBC1.SHUT

Suitable for the collection of strongly odorous bags. Thanks to the particular automatic bag closure which is equipped with a simple pedal, odour emission is avoided.

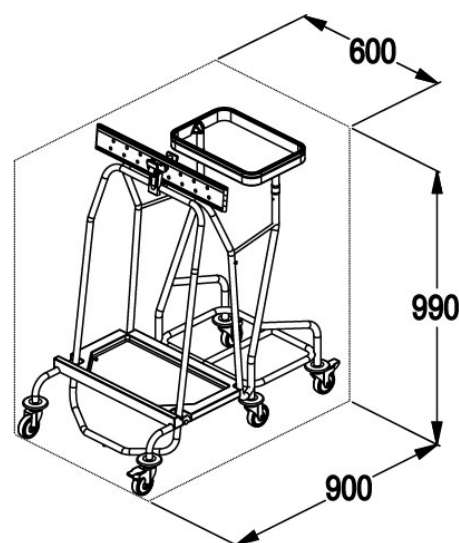

Built with a stainless steel AISI 304 (1.4301) tubular structure, corrosion and disinfectant resistant. The top opening is made of glass rubber hot injected onto the stainless steel supporting structure, equipped with spring loaded closing levers that hold the bag securely. When the bag is in place it totally covers the top ring, so it cannot be soiled while filling the bag. White ABS plastic recessed base. Non marking grey rubber 80 mm diam. wheels with galvanized steel swivelling supports. The two front wheels have pedal operated brakes.

Bag holder trolley which joins the heat-sealed AXLBC1 characteristics with the qualities of SHUT, welded together.

Internal Height	Internal Width	Internal Depth	External Height	External Width	External Depth	Position	Ring Size	Diameter Wheels
0	0	0	990	900	600	0	350x255	80