

## AXLBC2

Suitable for transport of soiled linen bags (plastic or tissue) for various hospital departments.

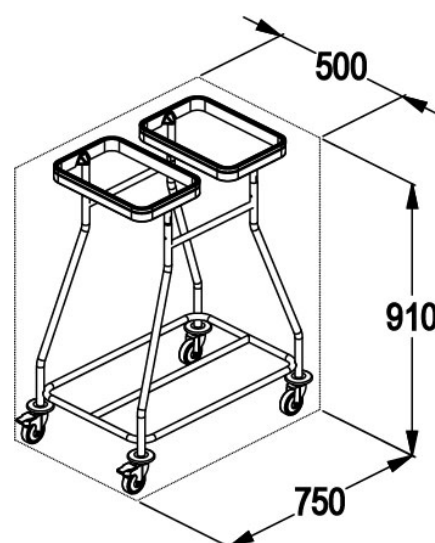

Rugged frame made of AISI 304 stainless steel (1.4301) tubes, completely welded with TIG process. Base is a complete ring curved at the corners. The vertical tubes that carry the bag holder ring are welded on the base ring. The bag holding ring (350x255 mm) is made of glass reinforced nylon with a rubber gasket hot-injected onto it to ensure it is an integral unit with no gaps, making it easier to clean and ensuring cleanliness and hygiene. The gasket holds the bag in place so it can not slip out without using clips. Non marking grey rubber 80 mm diam. wheels galvanized steel swivelling supports. The two front wheels have pedal operated brakes. Rubber disk bumpers on each corner.

Suitable for carrying 2 bags side by side.

Internal Height	Internal Width	Internal Depth	External Height	External Width	External Depth	Position	Ring Size	Diameter Wheels
0	0	0	910	750	500	0	350x255	80